

Optocoupler, Phototransistor Output, with Base Connection



21842



I179004-5

DESCRIPTION

Each optocoupler consists of gallium arsenide infrared LED and a silicon NPN phototransistor.

AGENCY APPROVALS

- Underwriters laboratory file no. E52744
- BSI: EN 60065:2002, EN 60950:2000
- FIMKO; EN 60065, EN 60335, EN 60950 certificate no. 25156

FEATURES

- Isolation test voltage 5000 V_{RMS}
- Interfaces with common logic families
- Input-output coupling capacitance < 0.5 pF
- Industry standard dual-in-line 6 pin package
- Compliant to RoHS directive 2002/95/EC and in accordance to WEEE 2002/96/EC

RoHS
COMPLIANT

APPLICATIONS

- AC mains detection
- Reed relay driving
- Switch mode power supply feedback
- Telephone ring detection
- Logic ground isolation
- Logic coupling with high frequency noise rejection

ORDER INFORMATION

PART	REMARKS
4N35	CTR > 100 %, DIP-6
4N36	CTR > 100 %, DIP-6
4N37	CTR > 100 %, DIP-6

ABSOLUTE MAXIMUM RATINGS (1)

PARAMETER	TEST CONDITION	SYMBOL	VALUE	UNIT
INPUT				
Reverse voltage		V _R	6	V
Forward current		I _F	50	mA
Surge current	t ≤ 10 μs	I _{FSM}	1	A
Power dissipation		P _{diss}	70	mW
OUTPUT				
Collector emitter breakdown voltage		V _{CEO}	70	V
Emitter base breakdown voltage		V _{EBO}	7	V
Collector current		I _C	50	mA
	t ≤ 1 ms	I _C	100	mA
Power dissipation		P _{diss}	70	mW
COUPLER				
Isolation test voltage		V _{ISO}	5000	V _{RMS}
Creepage			≥ 7	mm
Clearance			≥ 7	mm
Isolation thickness between emitter and detector			≥ 0.4	mm

ABSOLUTE MAXIMUM RATINGS (1)				
PARAMETER	TEST CONDITION	SYMBOL	VALUE	UNIT
COUPLER				
Comparative tracking index	DIN IEC 112/VDE 0303, part 1		175	
Isolation resistance	$V_{IO} = 500 \text{ V}, T_{amb} = 25 \text{ }^\circ\text{C}$	R_{IO}	10^{12}	Ω
	$V_{IO} = 500 \text{ V}, T_{amb} = 100 \text{ }^\circ\text{C}$	R_{IO}	10^{11}	Ω
Storage temperature		T_{stg}	- 55 to + 150	$^\circ\text{C}$
Operating temperature		T_{amb}	- 55 to + 100	$^\circ\text{C}$
Junction temperature		T_j	100	$^\circ\text{C}$
Soldering temperature (2)	max. 10 s dip soldering: distance to seating plane $\geq 1.5 \text{ mm}$	T_{sld}	260	$^\circ\text{C}$

Notes

(1) $T_{amb} = 25 \text{ }^\circ\text{C}$, unless otherwise specified.

Stresses in excess of the absolute maximum ratings can cause permanent damage to the device. Functional operation of the device is not implied at these or any other conditions in excess of those given in the operational sections of this document. Exposure to absolute maximum ratings for extended periods of the time can adversely affect reliability.

(2) Refer to wave profile for soldering conditions for through hole devices (DIP).

ELECTRICAL CHARACTERISTICS (1)								
PARAMETER	TEST CONDITION	PART	SYMBOL	MIN.	TYP.	MAX.	UNIT	
INPUT								
Junction capacitance	$V_R = 0 \text{ V}, f = 1 \text{ MHz}$		C_j		50		pF	
Forward voltage (2)	$I_F = 10 \text{ mA}$		V_F		1.3	1.5	V	
	$I_F = 10 \text{ mA}, T_{amb} = - 55 \text{ }^\circ\text{C}$		V_F	0.9	1.3	1.7	V	
Reverse current (2)	$V_R = 6 \text{ V}$		I_R		0.1	10	μA	
Capacitance	$V_R = 0 \text{ V}, f = 1 \text{ MHz}$		C_O		25		pF	
OUTPUT								
Collector emitter breakdown voltage(2)	$I_C = 1 \text{ mA}$	4N35	BV_{CEO}	30			V	
		4N36	BV_{CEO}	30			V	
		4N37	BV_{CEO}	30			V	
Emitter collector breakdown voltage(2)	$I_E = 100 \text{ } \mu\text{A}$		BV_{ECO}	7			V	
OUTPUT								
Collector base breakdown voltage (2)	$I_C = 100 \text{ } \mu\text{A}, I_B = 1 \text{ } \mu\text{A}$	4N35	BV_{CBO}	70			V	
		4N36	BV_{CBO}	70			V	
		4N37	BV_{CBO}	70			V	
Collector emitter leakage current (2)	$V_{CE} = 10 \text{ V}, I_F = 0$	4N35	I_{CEO}		5	50	nA	
		4N36	I_{CEO}		5	50	nA	
	$V_{CE} = 10 \text{ V}, I_F = 0$	4N37	I_{CEO}		5	50	nA	
	$V_{CE} = 30 \text{ V}, I_F = 0,$ $T_{amb} = 100 \text{ }^\circ\text{C}$	4N35	I_{CEO}				500	μA
		4N36	I_{CEO}				500	μA
		4N37	I_{CEO}				500	μA
Collector emitter capacitance	$V_{CE} = 0$		C_{CE}		6		pF	
COUPLER								
Resistance, input output (2)	$V_{IO} = 500 \text{ V}$		R_{IO}	10^{11}			Ω	
Capacitance, input output	$f = 1 \text{ MHz}$		C_{IO}		0.6		pF	

Notes

(1) $T_{amb} = 25 \text{ }^\circ\text{C}$, unless otherwise specified.

Minimum and maximum values are testing requirements. Typical values are characteristics of the device and are the result of engineering evaluation. Typical values are for information only and are not part of the testing requirements.

(2) Indicates JEDEC registered value.

CURRENT TRANSFER RATIO							
PARAMETER	TEST CONDITION	PART	SYMBOL	MIN	TYP.	MAX	UNIT
DC current transfer ratio ⁽¹⁾	$V_{CE} = 10 \text{ V}, I_F = 10 \text{ mA}$	4N35	CTR_{DC}	100			%
		4N36	CTR_{DC}	100			%
		4N37	CTR_{DC}	100			%
	$V_{CE} = 10 \text{ V}, I_F = 10 \text{ mA}, T_A = -55 \text{ }^\circ\text{C to } +100 \text{ }^\circ\text{C}$	4N35	CTR_{DC}	40	50		%
		4N36	CTR_{DC}	40	50		%
		4N37	CTR_{DC}	40	50		%

Note
⁽¹⁾ Indicates JEDEC registered values.

SWITCHING CHARACTERISTICS							
PARAMETER	TEST CONDITION	SYMBOL	MIN.	TYP.	MAX.	UNIT	
Switching time ⁽¹⁾	$V_{CC} = 10 \text{ V}, I_C = 2 \text{ mA}, R_L = 100 \text{ } \Omega$	t_{on}, t_{off}		10		μs	

Note
⁽¹⁾ Indicates JEDEC registered values.

TYPICAL CHARACTERISTICS
 $T_{amb} = 25 \text{ }^\circ\text{C}$, unless otherwise specified

Fig. 1 - Forward Voltage vs. Forward Current

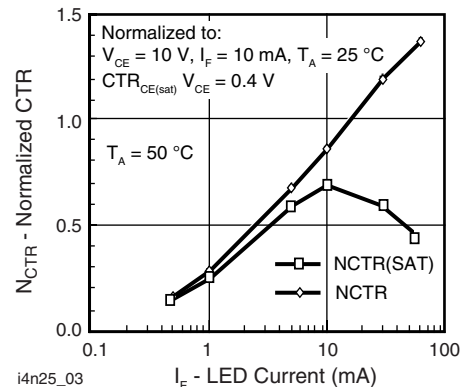

Fig. 3 - Normalized Non-Saturated and Saturated CTR vs. LED Current



Fig. 2 - Normalized Non-Saturated and Saturated CTR vs. LED Current



Fig. 4 - Normalized Non-Saturated and Saturated CTR vs. LED Current

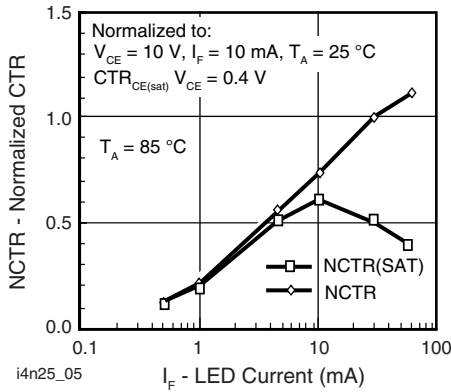

Fig. 5 - Normalized Non-Saturated and Saturated CTR vs. LED Current

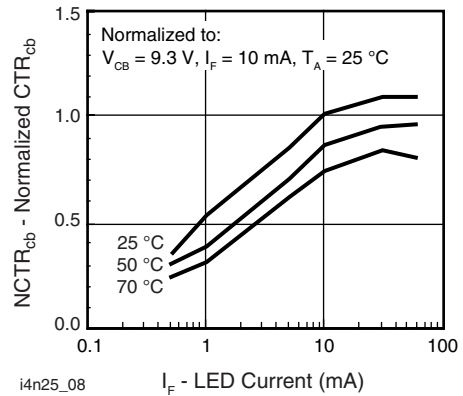

Fig. 8 - Normalized CTR_{cb} vs. LED Current and Temperature

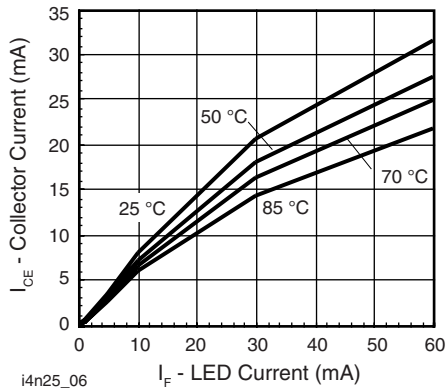

Fig. 6 - Collector Emitter Current vs. Temperature and LED Current

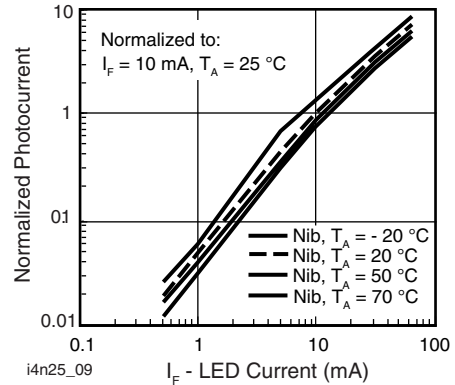

Fig. 9 - Normalized Photocurrent vs. I_F and Temperature

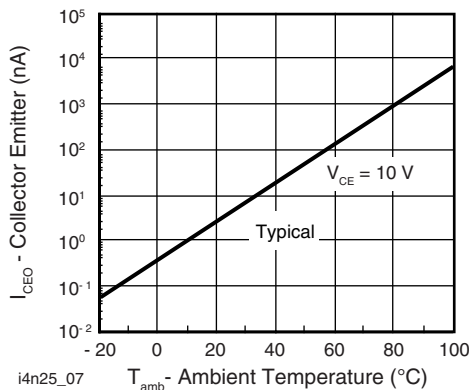

Fig. 7 - Collector Emitter Leakage Current vs. Temperature

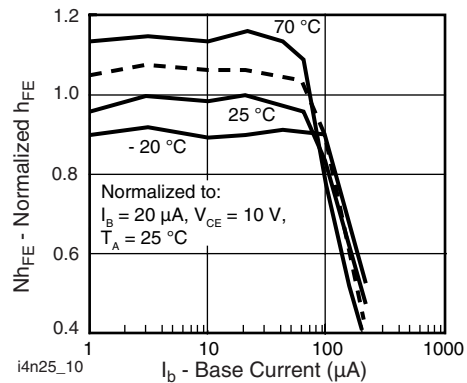

Fig. 10 - Normalized Non-Saturated h_{FE} vs. Base Current and Temperature

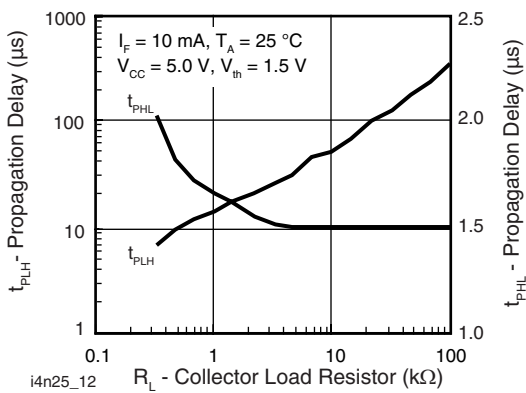

Fig. 11 - Normalized h_{FE} vs. Base Current and Temperature



i4n25_14

Fig. 14 - Switching Schematic



i4n25_12

Fig. 12 - Propagation Delay vs. Collector Load Resistor



i4n25_13

Fig. 13 - Switching Timing

4N35, 4N36, 4N37



Vishay Semiconductors Optocoupler, Phototransistor Output,
with Base Connection

PACKAGE DIMENSIONS in millimeters

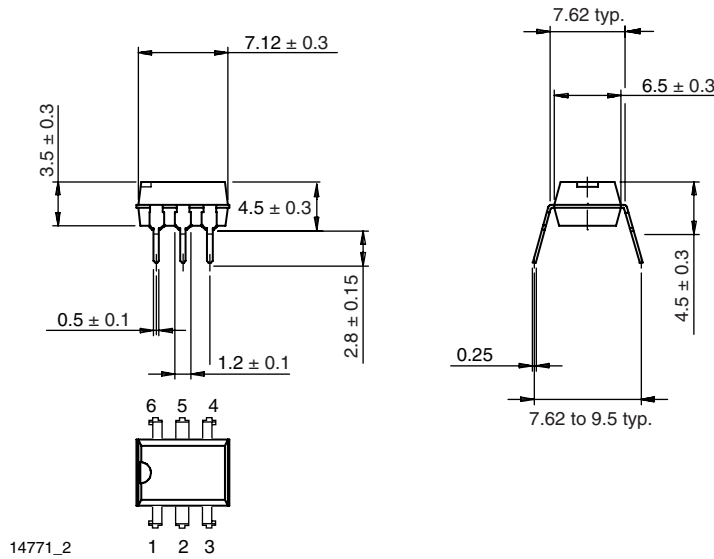

PACKAGE MARKING





Disclaimer

ALL PRODUCT, PRODUCT SPECIFICATIONS AND DATA ARE SUBJECT TO CHANGE WITHOUT NOTICE TO IMPROVE RELIABILITY, FUNCTION OR DESIGN OR OTHERWISE.

Vishay Intertechnology, Inc., its affiliates, agents, and employees, and all persons acting on its or their behalf (collectively, "Vishay"), disclaim any and all liability for any errors, inaccuracies or incompleteness contained in any datasheet or in any other disclosure relating to any product.

Vishay makes no warranty, representation or guarantee regarding the suitability of the products for any particular purpose or the continuing production of any product. To the maximum extent permitted by applicable law, Vishay disclaims (i) any and all liability arising out of the application or use of any product, (ii) any and all liability, including without limitation special, consequential or incidental damages, and (iii) any and all implied warranties, including warranties of fitness for particular purpose, non-infringement and merchantability.

Statements regarding the suitability of products for certain types of applications are based on Vishay's knowledge of typical requirements that are often placed on Vishay products in generic applications. Such statements are not binding statements about the suitability of products for a particular application. It is the customer's responsibility to validate that a particular product with the properties described in the product specification is suitable for use in a particular application. Parameters provided in datasheets and / or specifications may vary in different applications and performance may vary over time. All operating parameters, including typical parameters, must be validated for each customer application by the customer's technical experts. Product specifications do not expand or otherwise modify Vishay's terms and conditions of purchase, including but not limited to the warranty expressed therein.

Except as expressly indicated in writing, Vishay products are not designed for use in medical, life-saving, or life-sustaining applications or for any other application in which the failure of the Vishay product could result in personal injury or death. Customers using or selling Vishay products not expressly indicated for use in such applications do so at their own risk. Please contact authorized Vishay personnel to obtain written terms and conditions regarding products designed for such applications.

No license, express or implied, by estoppel or otherwise, to any intellectual property rights is granted by this document or by any conduct of Vishay. Product names and markings noted herein may be trademarks of their respective owners.